

# MATERIA

ELEGANT . CONCRETE



KRONOS

CERAMICHE

# MATERIA

ELEGANT . CONCRETE

  
KRONOS  
CERAMICHE

# Elegant Concrete

MATERIA è la nuova collezione che reinterpreta l'essenza del cemento, elevandola ad un linguaggio estetico moderno e raffinato. Ispirata alle lavorazioni artigianali come l'intonaco spatolato a mano, Materia riproduce fedelmente la gestualità e la profondità di superfici realizzate con calce, quarzi e impasti cementizi, trasformandole in un'interpretazione in gres porcellanato dal carattere autentico. Attraverso un attento studio della luce e della materia, la collezione restituisce sottili variazioni di lucentezza, ispirate ai riflessi naturali tipici del quarzo. Le texture evocano rilievi e irregolarità propri delle superfici lavorate a mano, dando vita a strutture visivamente marcate e tattili. MATERIA è caratterizzata da 9 colori attentamente selezionati, che spaziano tra tonalità calde, fredde e colori di tendenza. Ogni sfumatura è stata pensata per offrire la massima flessibilità creativa, arricchita da elementi decorativi a corredo che conferiscono un carattere unico a qualsiasi ambiente attraverso grafiche, tonalità, texture e una meticolosa cura dei particolari.

MATERIA is the new collection that reinterprets the essence of concrete, elevating it to a modern, refined aesthetic form. Inspired by artisanal procedures such as the hand-trowelled application of plaster, Materia accurately reproduces the crafted texture and depth of surfaces created in lime plaster, quartzes and cement mortars, in a porcelain stoneware version with a truly authentic character. Meticulous research into light and its interaction with matter has provided the collection with a subtly varied shine inspired by the natural glints of quartz. The uneven relief textures evoke hand-applied surfaces in their tactile, visually "flawed" structures. MATERIA offers 9 carefully selected colours, embracing warm, cool and trendy tones. Every specific shade is intended to deliver unrivalled creative freedom, extended by decors that give any location a unique personality, through graphic patterning, colour shades, textures and meticulous attention to details.

MATERIA est la nouvelle collection qui réinterprète l'essence du béton en l'élevant à un langage esthétique moderne et raffiné. Inspirée des façonnages artisanaux tels que l'enduit taloché à la main, Materia reproduit fidèlement la gestuelle et la profondeur des surfaces réalisées avec chaux, quartz et pâtes cimentaires, en les transformant en une interprétation en grès cérame au caractère authentique. Grâce à une étude minutieuse de la lumière et de la matière, la collection restitue de subtiles variations de brillance, rappelant les reflets naturels typiques du quartz. Les textures évoquent les reliefs et irrégularités propres aux surfaces façonnées à la main, donnant vie à des structures visuellement marquées et tactiles. MATERIA se distingue par 9 couleurs soigneusement sélectionnées, allant des tonalités chaudes et froides aux couleurs de tendance. Enrichie de graphismes, teintes, textures et détails méticuleusement soignés, chaque nuance a été formulée pour pousser au maximum la flexibilité créative : autant d'éléments décoratifs qui donnent un caractère unique à chaque espace.

Die neue Kollektion MATERIA interpretiert Beton in einer neuen Designsprache, die ihn auf eine höhere Stufe zeitgemäßer Ästhetik und Raffinesse hebt. Nach dem Vorbild handwerklicher Bearbeitungen, wie beispielsweise per Hand aufgetragener Putz, reproduziert Materia getreu die Struktur und Tiefe von Oberflächen, die mit Mischungen aus Kalk, Quarzsand und Zement hergestellt werden: eine Neuinterpretation in Feinsteinzeug mit authentischem Charakter. Durch sorgfältiges Abwägen der Lichtspiegelung und der Materie kann die Kollektion mit feinen Glanznuancen aufwarten, die die für Quarz typischen natürlichen Reflektionen wiedergeben. Die Texturen vermitteln das reliefartige Aussehen und die Unregelmäßigkeiten, die per Hand bearbeitete Oberflächen kennzeichnen, sodass der Eindruck sichtlich markierter und haptisch auffälliger Strukturen entsteht. MATERIA verfügt über neun sorgfältig ausgewählte Farbstellungen, die warme, kühle und trendige Nuancen umfassen. Jede Farbstellung wurde für größte gestalterische Freiheit konzipiert und wird durch Dekorelemente bereichert, deren Muster, Nuancen, Texturen und Detailverliebtheit jedem Raum einen einzigartigen Charakter verleihen.



# Cuore della materia

The heart of matter  
Au cœur de la matière  
Herz der materie

Ogni prodotto è stato realizzato con terre nobili a colore per garantire uniformità estetica in tutto lo spessore ed una profondità visiva naturale ed armoniosa. Questa tecnica produttiva garantisce una resistenza maggiore all'usura e allunga il ciclo di vita delle pavimentazioni, oltre a garantire una migliore estetica nelle lavorazioni speciali.

Each product is made from choice quality coloured clays to guarantee the same appearance throughout its thickness and a natural, appealing visual depth. This production technique ensures greater wear resistance and extends floor coverings' lifecycle, as well as guaranteeing a more attractive appearance for specially shaped pieces.

Chaque produit a été fabriqué avec des terres nobles colorées afin de garantir une uniformité esthétique à travers toute l'épaisseur et une profondeur visuelle naturelle et harmonieuse. Cette technique de production augmente la résistance à l'usure et prolonge la durée de vie des revêtements de sol, tout en garantissant une meilleure esthétique pour les façonnages spéciaux.

Alle Artikel der Kollektion bestehen aus edlen farbigen Erden, was für einen visuell einheitlichen Korpus und eine natürliche, harmonische Tiefenoptik sorgt. Diese Herstellungstechnik gewährleistet eine höhere Verschleißbeständigkeit und Standzeit von Bodenbelägen sowie eine wertigere Optik bei Spezialbearbeitungen.



# Identità decorativa

Decorative identity  
Identité décorative  
Dekorative identität

La collezione si completa con decori sabbiati e trame strutturate, studiati per il rivestimento.  
Elementi decorativi che interpretano la materia con discrezione e contemporaneità, mantenendo continuità estetica e valorizzando gli spazi con equilibrio e stile.

The collection is completed by sanded decors and structured textures designed for use in wall coverings.  
Decorative features that provide a contemporary, understated interpretation of matter, maintaining continuity of look and adding a stylish, tasteful beauty to design schemes.

La collection se complète avec des décors sablés et des trames structurées, conçus pour le revêtement mural.  
Des éléments décoratifs qui interprètent la matière avec discrétion et contemporanéité, tout en préservant la continuité esthétique et en valorisant les espaces avec équilibre et style.

Die Kollektion wird durch Sandstrahldekore und markante Texturen ergänzt, die für Wandverkleidungen vorgesehen sind.  
Dekorative Elemente interpretieren die Materie auf dezente und moderne Weise; sie bewahren die ästhetische Kontinuität und verleihen den Räumen stilistische Ausgewogenheit.





# Timeless Elegance

Raffinatezza senza tempo  
Refinement beyond the touch of time  
Un raffinement intemporel  
Zeitlose Raffinesse

Linee pulite e tonalità calde che creano spazi accoglienti,  
unendo modernità e delicata eleganza.

Clean lines and warm tones that create  
welcoming spaces, combining modernity and  
delicate elegance.

Des lignes épurées et des tons chaleureux  
qui créent des espaces accueillants, alliant  
modernité et élégance délicate.

Klare Linien und warme Töne schaffen  
einladende Räume und verbinden Modernität  
mit zarter Eleganz.

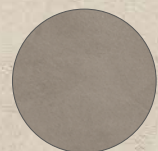

# Timeless Elegance

Tra volumi definiti e proporzioni equilibrate, una villa privata immersa nel verde che interpreta l'abitare contemporaneo come espressione di armonia ed equilibrio visivo. Spazi caratterizzati da un'estetica in continuità tra interno ed esterno, dove ogni materiale invita al contatto ed amplifica il senso di quiete. L'atmosfera è avvolgente, costruita con superfici tattili, luce naturale e arredi iconici scelti con misura. Una sintesi progettuale in cui la semplicità si fa eleganza senza tempo.



With its clearly defined volumes and balanced proportions, this private detached home in green surroundings interprets the contemporary lifestyle as an expression of tranquillity and visual harmony. Spaces with an aesthetic that runs seamlessly between indoors and outdoors, where every material is inviting to the touch and amplifies the sense of calm. The irresistible mood of comfort is constructed with tactile surfaces, natural lighting and carefully chosen, iconic furnishings. Immaculate design in which simplicity becomes timeless elegance.

Entre volumes définis et proportions équilibrées, une villa privée immergée dans la verdure qui interprète l'habitat contemporain comme une expression d'harmonie et d'équilibre visuel. Des espaces caractérisés par une esthétique en continuité entre intérieur et extérieur, où chaque matériau invite au contact et amplifie le sentiment de quiétude. L'atmosphère est enveloppante, construite avec des surfaces tactiles, la lumière naturelle et des pièces iconiques choisies avec soin. Une synthèse conceptuelle où la simplicité se transforme en élégance intemporelle.

Definierte Volumen und ausgewogene Proportionen kennzeichnen eine Privatvilla mitten im Grünen, die modernes Wohnen als Ausdruck der Harmonie und visuellen Ausgeglichenheit interpretiert. Auffallend ist die durchgehende Ästhetik zwischen Indoor und Outdoor der Räume, in denen jedes Material zur Berührung einlädt und das Gefühl entspannter Ruhe noch stärker werden lässt. Eine vertrauliche Atmosphäre, die durch haptisch angenehme Oberflächen, natürliches Licht und ikonische, mit Maß ausgesuchte Einrichtungen entsteht. Eine Synthese intelligenter Planung, in der die Einfachheit eine zeitlose Eleganz vermittelt.

**WALL:** MATERIA Cenere 120x280 - 48"x112" - MATERIA Kalle Strip Led Cenere 60 cm

**FLOOR:** MATERIA Cenere 2.0 60x120 - 24"x48" **STAIRCASES:** MATERIA Cenere 2.0 **PLANTER:** MATERIA Cenere





**WALL:** MATERIA Cenere 120x280 - 48"x112" - MATERIA Kalle Strip Led Cenere 120 cm  
**FLOOR:** MATERIA Cenere 2.0 120x120 - 48"x48" **POOL COPING:** MATERIA Cenere 2.0 **POOL:** MATERIA Sandalo



La matericità del cemento si traduce in un linguaggio coerente con il contesto, contribuendo a definire uno spazio esterno essenziale e armonico. La cura dei particolari rafforza il dialogo tra architettura e paesaggio, in un equilibrio silenzioso tra progetto e ambiente.

The textured concrete-effect surface speaks the same language as its context, helping to shape a minimalist yet tasteful outdoor area. Impeccably styled details reinforce the dialogue between architecture and landscape, as design and location merge in a wordless accord.

La matérialité du béton se traduit en un langage cohérent avec le contexte, contribuant à définir un espace extérieur essentiel et harmonieux. Le soin apporté aux détails renforce le dialogue entre architecture et paysage, dans un équilibre silencieux entre projet et environnement.

Der materialbetonte Charakter des Betons findet seinen Ausdruck in einer kontextkohärenten Sprache, die ihren Beitrag zur Definition eines essentiellen und harmonischen Außenambiente leistet. Die sorgfältige Auswahl der Details verstärkt den Dialog zwischen Architektur und Landschaft, der in einer stillen Ausgeglichenheit zwischen Projekt und Umgebung stattfindet.

**WALL:** MATERIA Cenere 120x280 - 48"x112" - MATERIA Kalle Strip Led Cenere 60 cm  
**FLOOR:** MATERIA Cenere 2.0 60x120 - 24"x48" **STAIRCASES:** MATERIA Cenere 2.0 **PLANTER:** MATERIA Cenere





**WALL:** MATERIA Cenere 120x280 - 48"x112" - MATERIA Kalle Strip Led Cenere 120 cm **FLOOR:** MATERIA Cenere 2.0 60x120 - 24"x48"  
**STAIRS:** MATERIA Cenere 2.0 **HOT TUB:** NATIVA Lapillo Vena **LOUNGER BASE:** NATIVA Lapillo Vena





**WALL:** MATERIA Cenere 120x280 - 48"x112" - MATERIA Cenere Hari 120x280 - 48"x112" - MATERIA Kalle Strip Led Cenere 120 cm  
**FLOOR:** MATERIA Cenere 120x120 - 48"x48" **TABLE:** MATERIA Cenere 2.0 - MATERIA Cenere Mini Baguette 3D  
**UNITS:** MATERIA Seta / Cenere / Tortora **VASES K-EDITION AUSTRALE:** K-GEO Seta / K-CATO Cenere / K-SAO Tortora

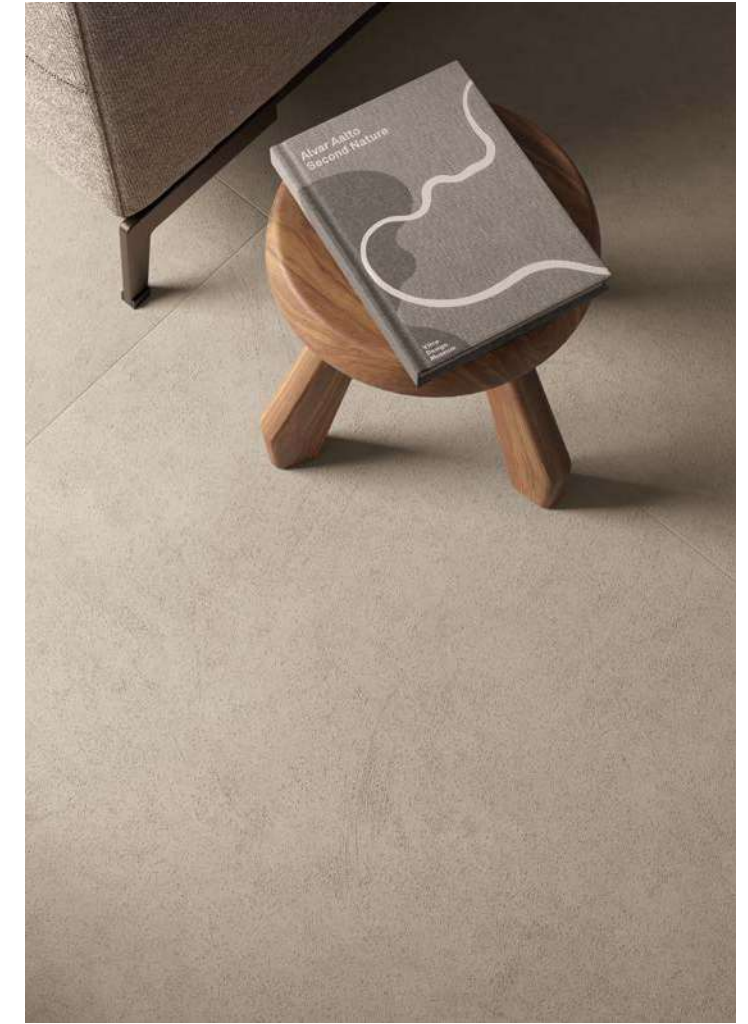
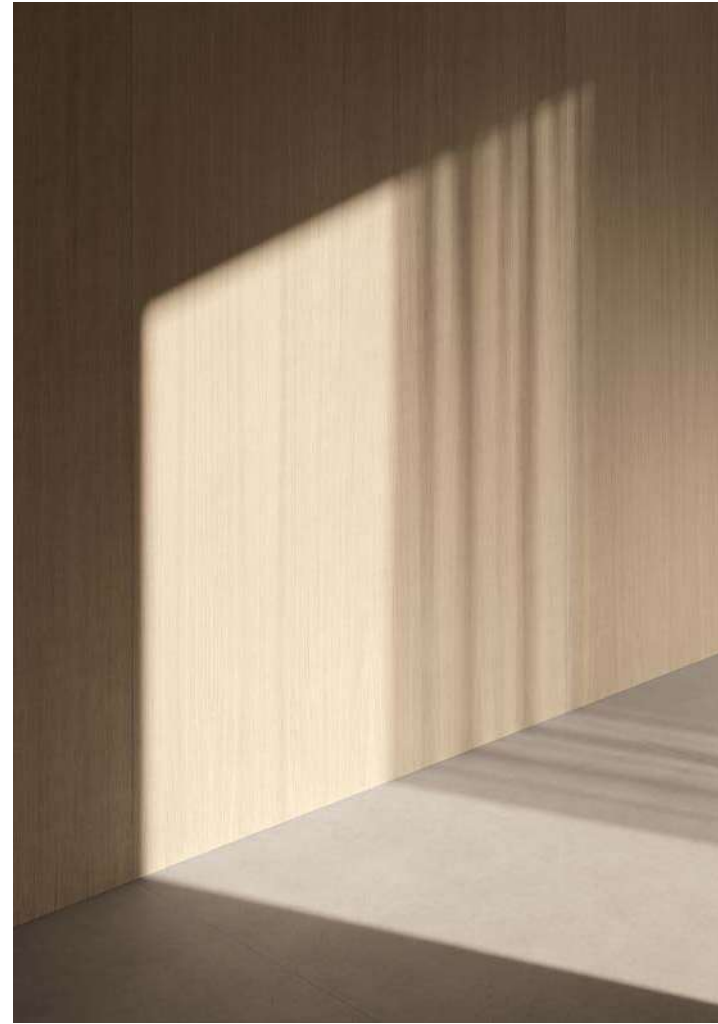

Gli interni si sviluppano in ambienti essenziali e armonici, dove luce naturale e materiali dialogano in equilibrio. Superfici e arredi selezionati con cura definiscono uno spazio misurato e visivamente continuo. Le ampie vetrate proiettano lo sguardo verso l'esterno, mantenendo una connessione coerente con l'insieme.

Indoors, natural lighting and materials tastefully combine in simple yet attractive interiors. Meticulously chosen surfaces and furnishings define an elegant, visually continuous space. The large windows make the outdoor view a constant feature and ensure that the context is always a part of the whole.

Les intérieurs se déploient en des espaces essentiels et harmonieux où la lumière naturelle et les matériaux dialoguent en équilibre. Des surfaces et des éléments d'ameublement soigneusement sélectionnés définissent un espace mesuré et visuellement continu. De larges baies vitrées ouvrent le regard vers l'extérieur, maintenant une connexion cohérente avec l'ensemble.

Die Innenbereiche entwickeln sich in essentielle und harmonische Räume, in denen das natürliche Licht und die Materialien einen ausgeglichenen Dialog miteinander führen. Sorgfältig ausgewählte Oberflächen und Einrichtungen definieren einen maßvoll gestalteten und visuell kontinuierlichen Raum. Die großen Glasfronten führen den Blick nach außen und übernehmen somit die Rolle eines wichtigen Bindeglieds innerhalb der gesamten Struktur.

**WALL:** MATERIA Cenere 120x280 - 48"x112" - MATERIA Cenere Hari 120x280 - 48"x112"  
**MATERIA** Kalle Strip Led Cenere 120 cm - ESSENCE Pure 120x280 - 48"x112"  
**FLOOR:** MATERIA Cenere 120x120 - 48"x48" **TABLES:** MATERIA Cenere 2.0 - MATERIA Cenere Mini Baguette 3D  
**UNITS:** MATERIA Seta / Cenere / Tortora **VASES K-EDITION AUSTRALE:** K-GEO Seta / K-CATO Cenere / K-SAO Tortora



**KITCHEN:** MATERIA Seta **KOVER KITCHEN:** MATERIA Seta  
**FLOOR:** MATERIA Tortora 120x120 - 48"x48"

**WALL:** MATERIA Trama Incenso 60x120 - 24"x48"  
**FLOOR:** MATERIA Tortora 120x120 - 48"x48"  
**TABLE:** MATERIA Seta 2.0 - Listellato Seta





**WALL:** MATERIA Linova Seta 120x280 - 48"x112"  
MATERIA Kalle Strip Led Cenere 90 cm  
**MIRROR FRAME:** MATERIA Seta  
**FLOOR:** MATERIA Seta 60x120 - 24"x48"  
**WASHBASIN:** NATIVA Vena Aurum



**WALL:** MATERIA Linova Seta 120x280 - 48"x112"  
 MATERIA Kalle Strip Led Cenere 90 cm  
**FRAME:** MATERIA Seta  
**FLOOR:** MATERIA Seta 60x120 - 24"x48"  
**WASHBASIN:** NATIVA Vena Aurum



**BOISERIE:** NATIVA Aurum Mini Baguette 3D 30x120 - 12"x48"  
**CLOSE:** MATERIA Seta 6x60 - 2 3/8"x24"  
**FLOOR:** MATERIA Seta 60x120 - 24"x48"



**WALL:** MATERIA Seta 120x280 - 48"x112"  
 MATERIA Linova Seta 120x280 - 48"x112"  
**BATHTUB:** NATIVA Vena Aurum  
**VASE:** K-EDITION AUSTRALE K-GEO Seta  
**UNIT:** MATERIA Trama Seta  
**FLOOR:** MATERIA Seta 60x120 - 24"x48"





Una variazione discreta nell'ambiente bagno, dove il colore si inserisce con misura, in dialogo con superfici decorate, luci soffuse e materiali naturali come pietra e legno.

There is a subtle variation in the bathroom, where colour is discreetly added, interacting with decorate surfaces, dim lighting and natural materials like stone and wood.

Une variation discrète dans la salle de bains, où la couleur s'inscrit avec mesure, en dialogue avec des surfaces décorées, des lumières tamisées et des matières naturelles comme la pierre et le bois.

Eine eher unauffällige Variation im Badezimmer, in dem die Farbe maßvoll Einzug hält und den Dialog mit dekorierten Oberflächen, der sanften Beleuchtung und natürlichen Materialien wie Stein und Holz aufnimmt.



**WALL:** MATERIA Incenso 120x280 - 48"x112" - MATERIA Linova Incenso 60x120 -24"x48" **NICHE:** MATERIA Incenso **SHELF:** MATERIA Tortora  
**FLOOR:** ESSENCE Pure 20x120 - 8"x48" **WASHBASIN:** MATERIA Tortora

# New Brutalism

L'essenza della materia

The essence of matter

L'essence de la matière

Das Wesen der Materie

Cemento a vista, geometrie decise e colori freddi per un ambiente essenziale e rigoroso.

Bare concrete, strong geometrical forms and cold colours for a simple, severe ambience.

Des lignes épurées et des tons chaleureux qui créent des espaces accueillants, alliant modernité et élégance délicate.

Klare Linien und warme Töne schaffen einladende Räume und verbinden Modernität mit zarter Eleganz.

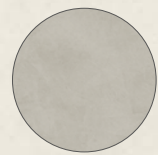
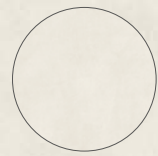

# New Brutalism

Una villa contemporanea che traduce il linguaggio brutalista in chiave residenziale, attraverso un'architettura rigorosa e forme scultoree. Il cemento diventa protagonista, superficie viva e mutevole, che dialoga con materiali naturali come legno e acciaio, introdotti con misura per creare contrasti materici. La stessa coerenza si ritrova tra interno ed esterno, in una continuità visiva che rafforza l'essenzialità degli spazi e ne amplifica il carattere autentico.



A contemporary detached home that offers a residential interpretation of Brutalism, with severe architecture and sculpted forms. Concrete plays a central role, its vibrant, changeable surface dialoguing with natural materials like wood and steel, skilfully introduced to create tactile contrasts. The same continuity recurs between indoors and outdoors, with a seamless visual effect that reinforces the project's simplicity and amplifies the sense of authenticity.

Une villa contemporaine qui traduit le langage brutaliste en clé résidentielle, à travers une architecture rigoureuse et des formes sculpturales. Le béton devient le protagoniste, surface vivante et changeante, qui dialogue avec des matériaux naturels comme le bois et l'acier, introduits avec mesure pour créer des contrastes de matière. La même cohérence se retrouve entre intérieur et extérieur, dans une continuité visuelle qui renforce l'essentiel des espaces et amplifie leur caractère authentique.

Eine moderne Villa, in der die Sprache des Brutalismus ihren Ausdruck in einem Wohnprojekt findet, das durch eine strenge Architektur und skulpturhafte Formen gekennzeichnet ist. Der Beton wird zum Protagonisten, zur lebendigen und veränderlichen Oberfläche, die mit natürlichen Materialien wie Holz und Stahl kommuniziert, deren Auswahl mit Augenmaß erfolgte, um materialbetonte Kontraste zu kreieren. Die gleiche Kohärenz ist zwischen Indoor und Outdoor zu beobachten, in einer visuellen Kontinuität, die die Nüchternheit der Räume und ihren authentischen Charakter verstärkt.

**WALL:** MATERIA Cemento 120x280 - 48"x112" - MATERIA Mini Baguette 3D Cemento 30x120 - 12"x48"  
**FLOOR:** MATERIA Cemento 2.0 120x120 - 48"x48"





**WALL:** MATERIA Cemento 120x280 - 48"x112" - Mosaico Cemento Mini Baguette 3D 30x120 - 12"x48"  
**FLOOR:** MATERIA Cemento 2.0 120x120 - 48"x48"



**WALL:** MATERIA Gesso 120x280 - 48"x112" **FLOOR:** MATERIA Cemento 120x120 - 48"x48"  
**VASE K-EDITION AUSTRALE:** K-ESO Pesca



**WALL:** MATERIA Gesso 120x280 - 48"x112" **FLOOR:** MATERIA Cemento 120x120 - 48"x48"  
**VASE K-EDITION AUSTRALE:** K-ESO Pesca





**WALL:** MATERIA Sandalo 120x280 - 48"x112" - MATERIA Cemento 120x280 - 48"x112" **FLOOR:** MATERIA Sandalo 120x120 - 48"x48"  
**KITCHEN:** MATERIA Cemento **KOVER KITCHEN:** MATERIA Linova Cemento **SHELF:** MATERIA Cemento



In the heart of the home, the kitchen offers a coherent, characterful expression of New Brutalism. Concrete, deployed in two shades, is completely predominant, appearing on the floors, walls and furniture and in functional features such as the island and sinks. A material that provides a pure, immaculate, contemporary design language.

Au cœur de la maison, la cuisine interprète les codes du New Brutalism avec cohérence et caractère : le béton, décliné en deux tonalités, devient le protagoniste absolu, modelant sols, revêtements muraux, meubles et volumes fonctionnels tels que l'îlot et les évier. Un langage pur, rigoureux et centré sur la matière, contemporain.

Im Herzen des Anwesens interpretiert die Küche die Codes des New Brutalism mit Kohärenz und Charakter: Der in zwei Farbstellungen deklinierte Beton wird zum absoluten Protagonisten, der Böden, Wände, Möbel und funktionale Volumen wie die Kücheninsel und die Waschbecken gestaltet. Eine reine, strenge und zeitgemäße materialbetonte Sprache.

Nel cuore della casa, la cucina interpreta i codici del New Brutalism con coerenza e carattere: il cemento, declinato in due tonalità, diventa protagonista assoluto, plasmando pavimenti, rivestimenti, mobili e volumi funzionali come l'isola e i lavabi. Un linguaggio materico puro, rigoroso e contemporaneo.



**WALL:** MATERIA Sandalo 120x280 - 48"x112" **FLOOR:** MATERIA Sandalo 120x120 - 48"x48"  
**KITCHEN:** MATERIA Cemento **KOVER KITCHEN:** MATERIA Linova Cemento **SHELF:** MATERIA Cemento





**WALL:** MATERIA Cemento 120x280 - 48"x112" - MATERIA Trama Cemento 60x120 - 24"x48" **FLOOR:** MATERIA Cemento 60x60 - 24"x24"  
**WASHBASIN:** MATERIA Cemento - MATERIA Trama Cemento **NICHE:** MATERIA Cemento



**WALL:** MATERIA Cemento 120x280 - 48"x112" - MATERIA Trama Cemento 60x120 - 24"x48"  
**WASHBASIN:** MATERIA Cemento / MATERIA Trama Cemento

**WALL:** MATERIA Trama Cemento 60x120 - 24"x48" **FLOOR:** MATERIA Cemento 60x60 - 24"x24"  
**BATHROOM FURNITURE:** Pillar MATERIA Cemento

# Natural Japandi

Armonia Naturale  
Natural harmony  
Harmonie Naturelle  
Natürliche Harmonie

Superfici sobrie e colori di tendenza che fondono estetica giapponese e scandinava in un equilibrio armonioso.

Understated surfaces and trendy colours that merge Japanese and Scandinavian aesthetics in a tasteful balance.

Des surfaces sobres et des couleurs tendance qui mélangent les esthétiques japonaises et scandinaves dans un équilibre harmonieux.

Schlichte Oberflächen und trendige Farben, die japanische und skandinavische Ästhetik in harmonischer Balance verbinden.

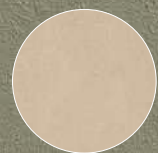

# Natural Japandi

Un resort&spa immerso nella vegetazione mediterranea, a pochi passi dal mare, dove l'architettura dialoga con il paesaggio in un equilibrio naturale. Volumi essenziali, materiali autentici e colori ispirati alla terra creano spazi che invitano a rallentare, alla cura di sé e ad una nuova idea di benessere. Un progetto in cui la sobrietà estetica incontra la quiete dello spirito.



A resort & spa immersed in Mediterranean vegetation, a short stroll from the sea, where the architecture dialogues with the landscape in a natural equilibrium. Simple forms, authentic materials and earthy colours create spaces that extend an invitation to slow down, take care of yourself and embrace a new idea of wellbeing. A project where an understated aesthetic brings calm to the soul.

Un resort & spa immergé dans la végétation méditerranéenne, à quelques pas de la mer, où l'architecture dialogue avec le paysage dans un équilibre naturel. Des volumes essentiels, des matériaux authentiques et des couleurs inspirées par la terre créent des espaces qui invitent à ralentir, à prendre soin de soi et à vivre une nouvelle idée de bien-être. Un projet où la sobriété esthétique rencontre la quiétude de l'esprit.

Ein Resort&Spa inmitten mediterraner Vegetation, nur wenige Schritte vom Meer entfernt, wo die Architektur in natürlicher Ausgewogenheit den Dialog mit der Landschaft aufnimmt. Essentielle Volumen, authentische Materialien und erdige Farbtöne kreieren Räume, die dazu einladen, den Rhythmus zu verlangsamen, Körper und Geist zu pflegen und eine neue Idee des Wohlbefindens auszuleben. Ein Projekt, in dem die ästhetische Nüchternheit auf die Ruhe des Geistes trifft.

**WALL:** MATERIA Tortora 120x280 - 48"x112" **FLOOR:** Tortora 2.0 120x120 - 48"x48"  
**PATH LIGHTS:** MATERIA Tortora





WALL: MATERIA Tortora 120x280 - 48"x112" SHOWER WALL: MATERIA Oliva 120x280 - 48"x112" FLOOR: MATERIA Tortora 2.0 120x120 - 48"x48"  
POOL: MATERIA Tortora PLANTER: MATERIA Tortora 2.0 LOUNGER BASE: ESSENCE Ambre TABLES: MATERIA Cenere



Gli spazi esterni e l'ampia piscina si inseriscono con naturalezza nel paesaggio, in un equilibrio attento tra forme, materiali e vegetazione. Ogni dettaglio – dai bordi su misura agli arredi integrati – restituisce un'idea di cura silenziosa, trasformando l'area all'aperto in uno spazio di armonia e contemplazione.

**FLOOR:** MATERIA Tortora 2.0 120x120 - 48"x48" **POOL:** MATERIA Tortora **PLANTER:** MATERIA Tortora 2.0  
**LOUNGER BASE:** ESSENCE Ambre **TABLES:** MATERIA Cenere **BASE:** ESSENCE Ambre



The outdoor areas and large swimming pool fit naturally into the landscape, with a beautifully chosen mix of forms, materials and vegetation. Every detail – from the bespoke edges to the built-in furnishings – inspires an idea of silent care, transforming the outdoor area into a place of harmony and contemplation.

Les espaces extérieurs et la vaste piscine s'intègrent avec naturel dans le paysage, dans un équilibre subtil entre formes, matériaux et végétation. Chaque détail – des bords sur mesure aux aménagements intégrés – exprime une idée de soin discret, transformant l'espace extérieur en un lieu d'harmonie et de contemplation.

Die Außenbereiche und der große Swimmingpool fügen sich auf natürliche Weise in die Landschaft ein; es entsteht ein harmonisches Gleichgewicht zwischen Formen, Materialien und Vegetation. Jedes Detail – von den maßgeschneiderten Beckenrändern bis hin zu den integrierten Einrichtungen – vermittelt die Idee einer geräuschlosen Sorgfalt, die den Außenbereich in einen Raum der Harmonie und Kontemplation verwandelt.



**FLOOR:** MATERIA Tortora 2.0 120x120 - 48"x48"  
**PLANTERS:** MATERIA Tortora 2.0 **BASE:** ESSENCE Ambre



Gli spazi comuni accolgono gli ospiti in ambienti silenziosi e curati, dove materiali naturali, arredi su misura e dettagli scultorei definiscono un'estetica equilibrata e coerente. Un percorso visivo fatto di forme essenziali e texture raffinate che accompagna verso le suite, anticipandone l'atmosfera raccolta e i richiami alla natura.

**FLOOR:** MATERIA Cenere 60x120 - 24"x48"  
**STAIR:** MATERIA Cenere



The communal areas welcome guests with immaculate, quiet interiors, where natural materials, bespoke furnishings and sculpted details create a balanced, coherent aesthetic. A visual sequence of simple forms and exquisite textures leads to the suites, with a foretaste of their intimate mood and natural touches.

Les espaces communs accueillent les clients dans des environnements silencieux et soignés, où matériaux naturels, mobilier sur mesure et détails sculpturaux définissent une esthétique équilibrée et cohérente. Un parcours visuel fait de formes essentielles et de textures raffinées conduit vers les suites, en anticipant leur atmosphère intime et leurs rappels à la nature.

Die Allgemeinbereiche präsentieren sich den Gästen als ruhige und gepflegte Räume, in denen natürliche Materialien, maßgeschneiderte Einrichtungen und skulpturhafte Details eine ausgewogene und kohärente Ästhetik definieren. Ein visueller Parcours aus essentiellen Formen und raffinierten Texturen, der zu den Suiten führt und dabei deren friedliche Atmosphäre und die Verweise auf die Natur vorwegnimmt.

**WALL:** MATERIA Cenere 120x280 - 48"x112" **FLOOR:** MATERIA Cenere 60x120 - 24"x48"  
**UNITS:** MATERIA Trama Pesca **VASE K-EDITION AUSTRALE:** K-ESO Pesca



WALL: MATERIA Oliva 120x280 - 48"x112" - MATERIA Edelis Oliva 120x280 - 48"x112" - MATERIA Kalle Strip Led Oliva 60 cm  
FLOOR: ESSENCE Ambre 26,5x180 - 10 1/2"x72" OUTDOOR FLOOR: MATERIA Tortora 2.0 120x120 - 48"x48"  
PLANTERS: Tortora 2.0 LOUNGER BASE: ESSENCE Ambre WASHBASIN: MATERIA Pesca



**WALL:** MATERIA Oliva 120x280 - 48"x112"  
 ECO MATERIA Mosaico 3x3 Oliva 30x30 - 12"x12"  
**FLOOR:** ECO MATERIA Mosaico 3x3 Oliva 30x30 - 12"x12"  
**NICHE:** MATERIA Oliva **BENCH:** MATERIA Oliva



**WALL:** MATERIA Oliva 120x280 - 48"x112"  
 MATERIA Edelis Oliva 120x280 - 48"x112"  
**FLOOR:** ESSENCE Ambre 26,5x180 - 10<sup>1</sup>/<sub>2</sub>"x72"  
**OUTDOOR FLOOR:** MATERIA Tortora 2.0 120x120 - 48"x48"  
**WASHBASIN:** MATERIA Pesca  
**PLANTER:** Tortora 2.0 **NICHE:** MATERIA Oliva





**WALL:** MATERIA Tortora 120x280 - 48"x112" **FLOOR:** MATERIA Tortora 2.0 120x120 - 48"x48" - ESSENCE Ambre Deck 2.0 26,5x180 - 10 1/2"x72"  
**HOT POOL:** MATERIA Tortora **PLANTERS:** MATERIA Tortora 2.0



**WALL:** MATERIA Pesca 120x280 - 48"x112" - MATERIA Pesca Mini Baguette 3D 30x120 - 12"x48" **CLOSE:** MATERIA Pesca 6x60 - 2<sup>3</sup>/<sub>8</sub>"x24"  
**FLOOR:** MATERIA Tortora Grip 60x120 - 24"x48" **BENCH:** MATERIA Pesca



**WALL:** MATERIA Pesca 120x280 - 48"x112" - MATERIA Edelis Pesca 120x280 - 48"x112" - ECO MATERIA Mosaico 1x1 Pesca 30x30 - 12"x12"  
**FLOOR:** MATERIA Tortora 60x60 - 24"x24" - ECO MATERIA Mosaico 1x1 Pesca 30x30 - 12"x12"

Un luogo di rigenerazione profonda, dove ogni spazio è pensato per favorire la cura del corpo e dello spirito. Linee minimaliste, luci morbide e superfici materiche definiscono un ambiente raccolto e contemplativo. Colori tenui e rassicuranti accompagnano il visitatore in un percorso sensoriale che alterna acqua, silenzio e relax, in piena continuità con l'identità estetica del progetto.

**WALL:** MATERIA Pesca 120x280 - 48"x112" - ECO MATERIA Mosaico 1x1 Oliva 30x30 - 12"x12"  
**FLOOR:** MATERIA Tortora Grip 60x120 - 24"x48" **UNIT:** MATERIA Oliva



A place of profound regeneration, where every space is carefully designed to care for the body and spirit. Minimalist lines, soft lighting and tactile surfaces create an intimate, contemplative ambience. Delicate, reassuring colours guide the visitor in a sensory experience that alternates water, silence and relaxation, in complete coherence with the project's aesthetic identity.

Un lieu de régénération profonde, où chaque espace est conçu pour favoriser le soin du corps et de l'esprit. Des lignes minimalistes, des lumières suaves et des surfaces à effet de matière définissent un environnement intime et contemplatif. Des couleurs douces et rassurantes accompagnent le visiteur dans un parcours sensoriel alternant eau, silence et détente, en parfaite continuité avec l'identité esthétique du projet.

Ein Ort zur echten Regeneration, wo jeder Raum zur nachhaltigen Pflege von Körper und Geist beiträgt. Minimalistische Linien, sanfte Beleuchtung und materialbetonte Oberflächen definieren ein friedliches und kontemplatives Ambiente. Dezent und beruhigende Farben begleiten den Besucher auf einem für die Sinne anmutsvollen Weg, auf dem Wasser, Ruhe und Relax Hand in Hand gehen und eine gemeinsame Linie mit der ästhetischen Identität des Projekts bilden.

**WALL:** MATERIA Oliva 120x280 - 48"x112" **FLOOR:** MATERIA Tortora Grip 60x120 - 24"x48"  
**LOUNGER:** ECO MATERIA Mosaico 1x1 Oliva 30x30 - 12"x12"



**SETA**

**6 mm**

- 120x280** - 48"x112"
- 120x120** - 48"x48"
- 60x120** - 24"x48"

**9 mm**

- 120x120** - 48"x48"
- 120x120** - 48"x48" Grip
- 60x120** - 24"x48"
- 60x120** - 24"x48" Grip
- 80x80** - 32"x32"
- 80x80** - 32"x32" Grip
- 60x60** - 24"x24"

**SKE2.0**

**20 mm**

- 120x120** - 48"x48"
- 60x120** - 24"x48"

**CENERE**

**6 mm**

- 120x280** - 48"x112"
- 120x120** - 48"x48"
- 60x120** - 24"x48"

**9 mm**

- 120x120** - 48"x48"
- 120x120** - 48"x48" Grip
- 60x120** - 24"x48"
- 60x120** - 24"x48" Grip
- 80x80** - 32"x32"
- 80x80** - 32"x32" Grip
- 60x60** - 24"x24"

**SKE2.0**

**20 mm**

- 120x120** - 48"x48"
- 60x120** - 24"x48"

**TORTORA**

**6 mm**

- 120x280** - 48"x112"
- 120x120** - 48"x48"
- 60x120** - 24"x48"

**9 mm**

- 120x120** - 48"x48"
- 120x120** - 48"x48" Grip
- 60x120** - 24"x48"
- 60x120** - 24"x48" Grip
- 80x80** - 32"x32"
- 80x80** - 32"x32" Grip
- 60x60** - 24"x24"

**SKE2.0**

**20 mm**

- 120x120** - 48"x48"
- 60x120** - 24"x48"



**GESSO**

**6 mm**

- 120x280** - 48"x112"
- 120x120** - 48"x48"
- 60x120** - 24"x48"

**9 mm**

- 120x120** - 48"x48"
- 120x120** - 48"x48" Grip
- 60x120** - 24"x48"
- 60x120** - 24"x48" Grip
- 80x80** - 32"x32"
- 80x80** - 32"x32" Grip
- 60x60** - 24"x24"

**SKE2.0**

**20 mm**

- 120x120** - 48"x48"
- 60x120** - 24"x48"

**CEMENTO**

**6 mm**

- 120x280** - 48"x112"
- 120x120** - 48"x48"
- 60x120** - 24"x48"

**9 mm**

- 120x120** - 48"x48"
- 120x120** - 48"x48" Grip
- 60x120** - 24"x48"
- 60x120** - 24"x48" Grip
- 80x80** - 32"x32"
- 80x80** - 32"x32" Grip
- 60x60** - 24"x24"

**SKE2.0**

**20 mm**

- 120x120** - 48"x48"
- 60x120** - 24"x48"

**SANDALO**

**6 mm**

- 120x280** - 48"x112"
- 120x120** - 48"x48"
- 60x120** - 24"x48"

**9 mm**

- 120x120** - 48"x48"
- 120x120** - 48"x48" Grip
- 60x120** - 24"x48"
- 60x120** - 24"x48" Grip
- 80x80** - 32"x32"
- 80x80** - 32"x32" Grip
- 60x60** - 24"x24"

**SKE2.0**

**20 mm**

- 120x120** - 48"x48"
- 60x120** - 24"x48"



PESCA

6 mm

120x280 - 48"x112"

120x120 - 48"x48"

60x120 - 24"x48"

9 mm

60x120 - 24"x48"

OLIVA

6 mm

120x280 - 48"x112"

120x120 - 48"x48"

60x120 - 24"x48"

9 mm

60x120 - 24"x48"

INCENSO

6 mm

120x280 - 48"x112"

120x120 - 48"x48"

60x120 - 24"x48"

9 mm

60x120 - 24"x48"

# MATERIA

ELEGANT . CONCRETE

TRAMA

9 mm

60x120 - 24"x48"

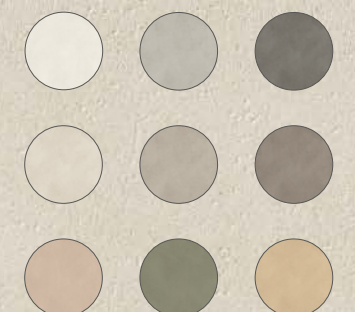
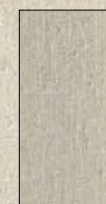



LINOVA

6 mm

120x280 - 48"x112"

9 mm

60x120 - 24"x48"

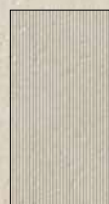

EDELIS

6 mm

120x280 - 48"x112"

9 mm

60x120 - 24"x48"

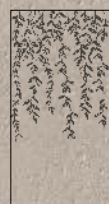

HARI

6 mm

120x280 - 48"x112"

9 mm

60x120 - 24"x48"





MOSAICO LISTELLATO

9 mm

15x120 - 6"x48"



MOSAICO MINI BAGUETTE 3D

9 mm

30x120 - 12"x48"



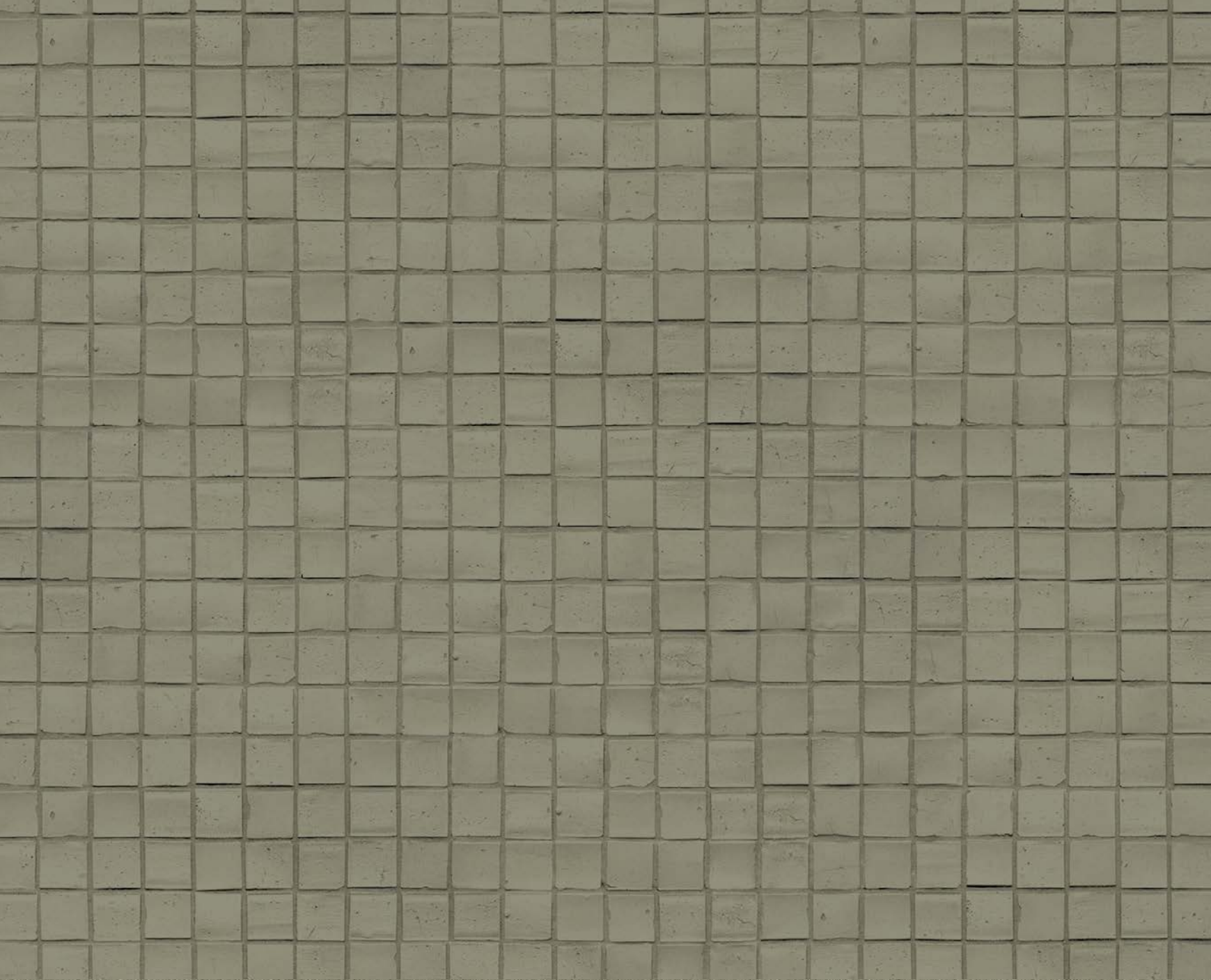
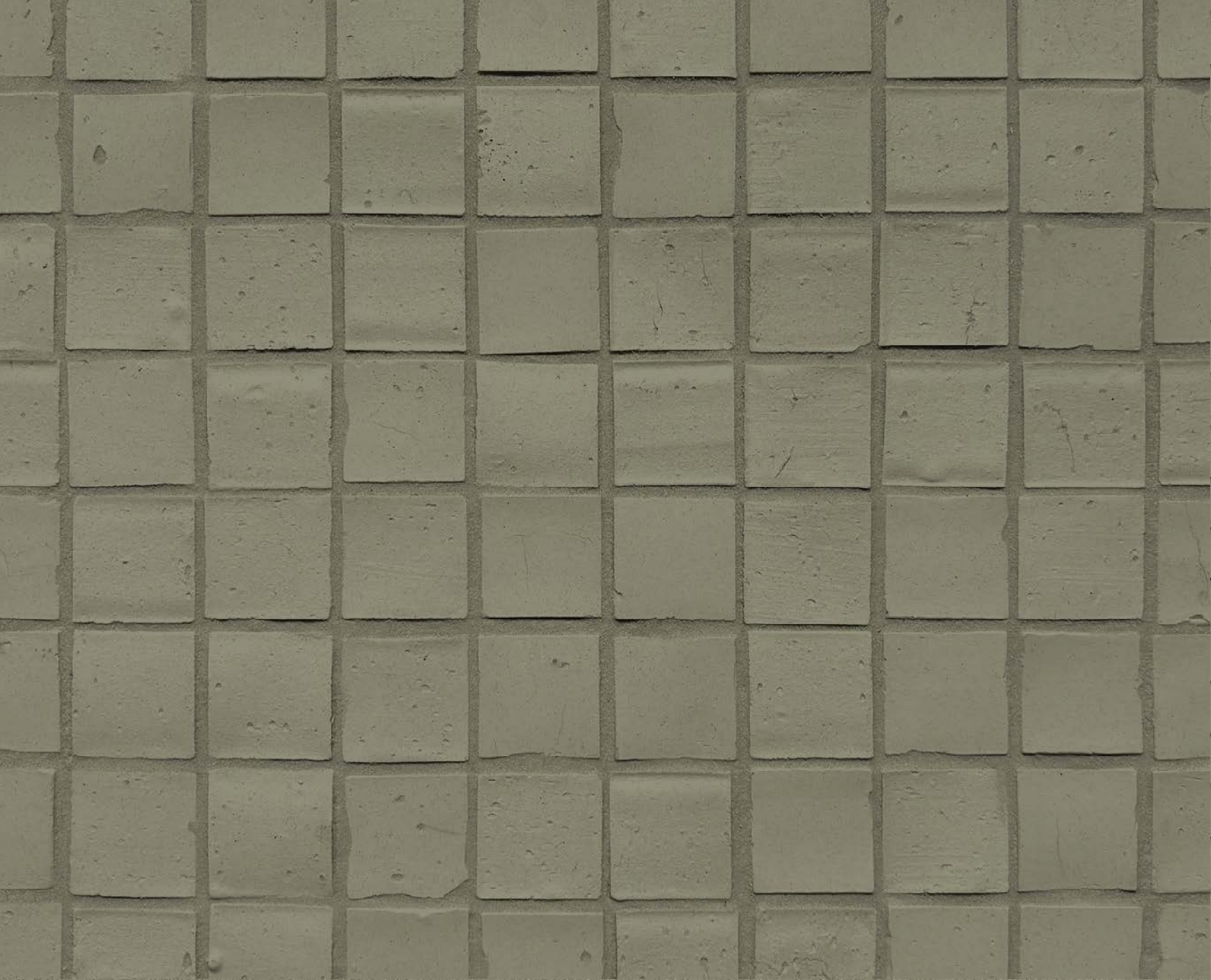

**MOSAICO 3x3**

**3 mm**

**30x30** - 12"x12"  
tessere 3x3



**ECO MATERIA**

**Impasti di argille colorate ed elevate % di vetro riciclato**  
Coloured clay body mixes with high % of recycled glass



**MOSAICO 1x1**

**4 mm**

**30x30** - 12"x12"  
tessere 1x1

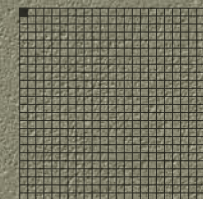

**ECO MATERIA**

**Impasti di argille colorate ed elevate % di vetro riciclato**  
Coloured clay body mixes with high % of recycled glass



# Beyond the Stoneware

Si allarga la proposta commerciale offerta da Kronos. Non ci limitiamo ad offrire i nuovi mobili rivestiti in gres, ma proponiamo anche soluzioni in legno laccato, disponibili in una gamma di colorazioni esclusive. Ogni tonalità è stata attentamente studiata per armonizzarsi alla perfezione con la palette cromatica della collezione Materia, garantendo la creazione di elementi unici, versatili e contemporanei.

Kronos has extended its commercial offering. No longer only offering our new stoneware-clad furniture, we now also have lacquered wood solutions in a range of exclusive colours. Each shade has been carefully chosen to harmonise perfectly with the Materia collection's colour range, creating unique, versatile, contemporary interior design features.

L'offre commerciale de Kronos s'élargit. Nous ne nous contentons pas d'offrir les nouveaux meubles en grès, mais nous proposons également des solutions en bois laqué, disponibles dans une gamme de coloris exclusifs. Chaque teinte a été soigneusement étudiée pour s'accorder parfaitement avec la palette couleur de la collection Materia, garantissant la création d'éléments uniques, polyvalents et contemporains.

Kronos erweitert sein Produktprogramm. Neben neuen mit Feinsteinzeug verkleideten Möbeln wartet der Hersteller auch mit Produkten aus lackiertem Holz in exklusiven Farben auf. Jeder Farbton wurde mit größter Sorgfalt passend zur Farbpalette der Kollektion Materia ausgewählt, was die Gestaltung von einzigartigen, vielseitigen und zeitgemäßen Einrichtungselementen ermöglicht.





**K-SAO  
TORTORA**

**Dimensione:**  
L 21 cm  
P 12 cm  
H 50 cm

**Materiale:**  
Terracotta  
semirefrettaria

**Dimensions:**  
W 21 cm  
D 12 cm  
H 50 cm

**Material:**  
Semi-refractory  
terracotta



**K-CATO  
CENERE**

**Dimensione:**  
L 21,5 cm  
P 12 cm  
H 44 cm

**Materiale:**  
Terracotta  
semirefrettaria

**Dimensions:**  
W 21,5 cm  
D 12 cm  
H 44 cm

**Material:**  
Semi-refractory  
terracotta



**K-GEO  
SETA**

**Dimensione:**  
L 17,5 cm  
P 12 cm  
H 36 cm

**Materiale:**  
Terracotta  
semirefrettaria

**Dimensions:**  
W 17,5 cm  
D 12 cm  
H 36 cm

**Material:**  
Semi-refractory  
terracotta



**K-TA  
SANDALO**

**Dimensione:**  
L 22 cm  
P 12 cm  
H 46 cm

**Materiale:**  
Terracotta  
semirefrettaria

**Dimensions:**  
W 22 cm  
D 12 cm  
H 46 cm

**Material:**  
Semi-refractory  
terracotta



**K-CARE  
CEMENTO**

**Dimensione:**  
L 19 cm  
P 12 cm  
H 41 cm

**Materiale:**  
Terracotta  
semirefrettaria

**Dimensions:**  
W 19 cm  
D 12 cm  
H 41 cm

**Material:**  
Semi-refractory  
terracotta



**K-TOA  
GESSO**

**Dimensione:**  
L 24 cm  
P 14 cm  
H 45 cm

**Materiale:**  
Terracotta  
semirefrettaria

**Dimensions:**  
W 24 cm  
D 14 cm  
H 45 cm

**Material:**  
Semi-refractory  
terracotta



**K-OLO  
INCENSO**

**Dimensione:**  
L 22 cm  
P 12 cm  
H 49 cm

**Materiale:**  
Terracotta  
semirefrettaria

**Dimensions:**  
W 22 cm  
D 14 cm  
H 49 cm

**Material:**  
Semi-refractory  
terracotta



**K-PAO  
OLIVA**

**Dimensione:**  
L 21 cm  
P 12 cm  
H 55,5 cm

**Materiale:**  
Terracotta  
semirefrettaria

**Dimensions:**  
W 21 cm  
D 12 cm  
H 55,5 cm

**Material:**  
Semi-refractory  
terracotta



**K-ESO  
PESCA**

**Dimensione:**  
L 23 cm  
P 13 cm  
H 37 cm

**Materiale:**  
Terracotta  
semirefrettaria

**Dimensions:**  
W 23 cm  
D 13 cm  
H 37 cm

**Material:**  
Semi-refractory  
terracotta



# MATERIA

ELEGANT . CONCRETE

## KALLE STRIP LED

STRIPLED CABLATO COMPLETO DI ALIMENTATORE INTEGRATO 2700K  
Wired led strip light complete with integral 2700 k transformer



## KALLE STRIP LED

Strip led cablato completo di alimentatore integrato.  
Wired LED strip light complete with integral transformer.

KALLE strip led 60 cm - 24"  
KALLE strip led 90 cm - 36"  
KALLE strip led 120 cm - 48"

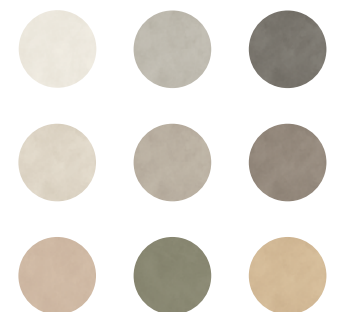
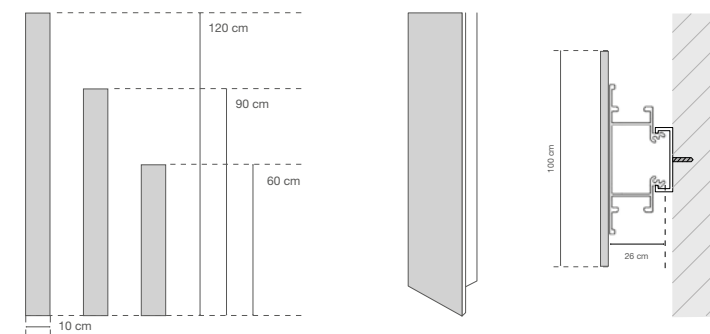

# MATERIA

ELEGANT . CONCRETE

## GESSO



**6 mm**

**120x280** - 48"x112"

MA001 GESSO

**120x120** - 48"x48"

MA016 GESSO

**60x120** - 24"x48"

MA193 GESSO

**9 mm**

**120x120** - 48"x48"

MA010 GESSO

**120x120** - 48"x48"

MA070 GESSO GRIP

**60x120** - 24"x48"

MA028 GESSO

**60x120** - 24"x48"

MA088 GESSO GRIP

**80x80** - 32"x32"

MA052 GESSO

**80x80** - 32"x32"

MA058 GESSO GRIP

**60x60** - 24"x24"

MA064 GESSO

**SKE 2.0**

**20 mm**

**120x120** - 48"x48"

MA082 GESSO

**60x120** - 24"x48"

MA037 GESSO

## CEMENTO



**6 mm**

**120x280** - 48"x112"

MA003 CEMENTO

**120x120** - 48"x48"

MA018 CEMENTO

**60x120** - 24"x48"

MA195 CEMENTO

**9 mm**

**120x120** - 48"x48"

MA012 CEMENTO

**120x120** - 48"x48"

MA072 CEMENTO GRIP

**60x120** - 24"x48"

MA030 CEMENTO

**60x120** - 24"x48"

MA090 CEMENTO GRIP

**80x80** - 32"x32"

MA054 CEMENTO

**80x80** - 32"x32"

MA060 CEMENTO GRIP

**60x60** - 24"x24"

MA066 CEMENTO

**SKE 2.0**

**20 mm**

**120x120** - 48"x48"

MA084 CEMENTO

**60x120** - 24"x48"

MA039 CEMENTO

## SANDALO

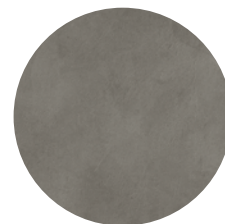

**6 mm**

**120x280** - 48"x112"

MA005 SANDALO

**120x120** - 48"x48"

MA020 SANDALO

**60x120** - 24"x48"

MA197 SANDALO

**9 mm**

**120x120** - 48"x48"

MA014 SANDALO

**120x120** - 48"x48"

MA074 SANDALO GRIP

**60x120** - 24"x48"

MA032 SANDALO

**60x120** - 24"x48"

MA092 SANDALO GRIP

**80x80** - 32"x32"

MA056 SANDALO

**80x80** - 32"x32"

MA062 SANDALO GRIP

**60x60** - 24"x24"

MA068 SANDALO

**SKE 2.0**

**20 mm**

**120x120** - 48"x48"

MA086 SANDALO

**60x120** - 24"x48"

MA041 SANDALO

## SETA

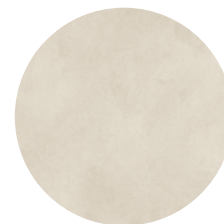

**6 mm**

**120x280** - 48"x112"

MA002 SETA

**120x120** - 48"x48"

MA017 SETA

**60x120** - 24"x48"

MA194 SETA

**9 mm**

**120x120** - 48"x48"

MA011 SETA

**120x120** - 48"x48"

MA071 SETA GRIP

**60x120** - 24"x48"

MA029 SETA

**60x120** - 24"x48"

MA089 SETA GRIP

**80x80** - 32"x32"

MA053 SETA

**80x80** - 32"x32"

MA059 SETA GRIP

**60x60** - 24"x24"

MA065 SETA

**SKE 2.0**

**20 mm**

**120x120** - 48"x48"

MA083 SETA

**60x120** - 24"x48"

MA038 SETA

## CENERE



**6 mm**

**120x280** - 48"x112"

MA004 CENERE

**120x120** - 48"x48"

MA019 CENERE

**60x120** - 24"x48"

MA196 CENERE

**9 mm**

**120x120** - 48"x48"

MA013 CENERE

**120x120** - 48"x48"

MA073 CENERE GRIP

**60x120** - 24"x48"

MA031 CENERE

**60x120** - 24"x48"

MA091 CENERE GRIP

**80x80** - 32"x32"

MA055 CENERE

**80x80** - 32"x32"

MA061 CENERE GRIP

**60x60** - 24"x24"

MA067 CENERE

**SKE 2.0**

**20 mm**

**120x120** - 48"x48"

MA085 CENERE

**60x120** - 24"x48"

MA040 CENERE

## TORTORA



**6 mm**

**120x280** - 48"x112"

MA006 TORTORA

**120x120** - 48"x48"

MA021 TORTORA

**60x120** - 24"x48"

MA198 TORTORA

**9 mm**

**120x120** - 48"x48"

MA015 TORTORA

**120x120** - 48"x48"

MA075 TORTORA GRIP

**60x120** - 24"x48"

MA033 TORTORA

**60x120** - 24"x48"

MA093 TORTORA GRIP

**80x80** - 32"x32"

MA057 TORTORA

**80x80** - 32"x32"

MA063 TORTORA GRIP

**60x60** - 24"x24"

MA069 TORTORA

**SKE 2.0**

**20 mm**

**120x120** - 48"x48"

MA087 TORTORA

**60x120** - 24"x48"

MA042 TORTORA

## PESCA

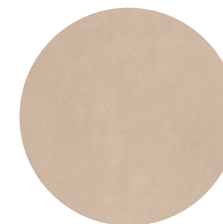

**6 mm**

**120x280** - 48"x112"

MA008 PESCA

**120x120** - 48"x48"

MA023 PESCA

**60x120** - 24"x48"

MA200 PESCA

**9 mm**

**60x120** - 24"x48"

MA035 PESCA

## OLIVA

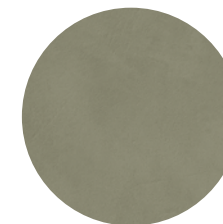

**6 mm**

**120x280** - 48"x112"

MA009 OLIVA

**120x120** - 48"x48"

MA024 OLIVA

**60x120** - 24"x48"

MA201 OLIVA

**9 mm**

**60x120** - 24"x48"

MA036 OLIVA

## INCENSO



**6 mm**

**120x280** - 48"x112"

MA007 INCENSO

**120x120** - 48"x48"

MA022 INCENSO

**60x120** - 24"x48"

MA199 INCENSO

**9 mm**

**60x120** - 24"x48"

MA034 INCENSO

# MATERIA

ELEGANT . CONCRETE

## TRAMA

### GESSO



9 mm

60x120 - 24"x48"

MA043 GESSO

### CEMENTO

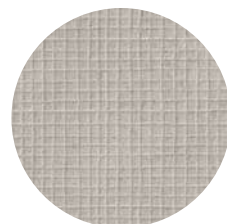

9 mm

60x120 - 24"x48"

MA045 CEMENTO

### SANDALO

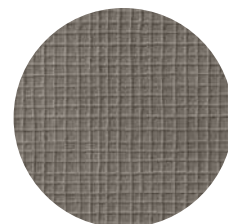

9 mm

60x120 - 24"x48"

MA047 SANDALO

### SETA

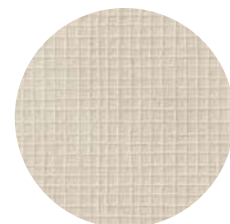

9 mm

60x120 - 24"x48"

MA044 SETA

### CENERE

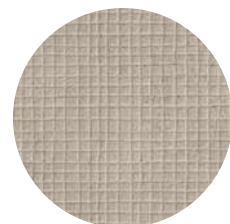

9 mm

60x120 - 24"x48"

MA046 CENERE

### TORTORA

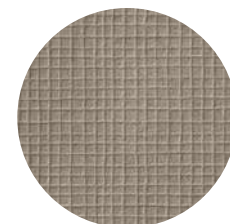

9 mm

60x120 - 24"x48"

MA048 TORTORA

### PESCA

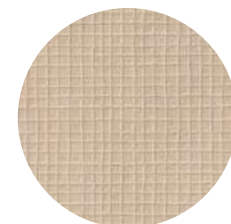

9 mm

60x120 - 24"x48"

MA050 PESCA

### OLIVA

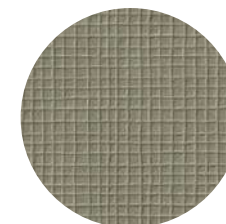

9 mm

60x120 - 24"x48"

MA051 OLIVA

### INCENSO

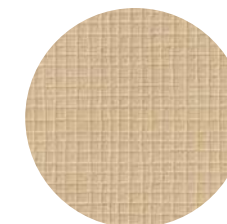

9 mm

60x120 - 24"x48"

MA049 INCENSO

## EDELIS

### GESSO



6 mm

120x280 - 48"x112"

MA130 GESSO

### CEMENTO



6 mm

120x280 - 48"x112"

MA132 CEMENTO

### SANDALO



6 mm

120x280 - 48"x112"

MA134 SANDALO

### SETA



6 mm

120x280 - 48"x112"

MA131 SETA

### CENERE



6 mm

120x280 - 48"x112"

MA133 CENERE

### TORTORA

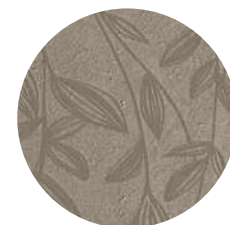

6 mm

120x280 - 48"x112"

MA135 TORTORA

### PESCA



6 mm

120x280 - 48"x112"

MA137 PESCA

### OLIVA



6 mm

120x280 - 48"x112"

MA138 OLIVA

### INCENSO



6 mm

120x280 - 48"x112"

MA136 INCENSO

9 mm

60x120 - 24"x48"

MA139 GESSO

9 mm

60x120 - 24"x48"

MA141 CEMENTO

9 mm

60x120 - 24"x48"

MA143 SANDALO

9 mm

60x120 - 24"x48"

MA140 SETA

9 mm

60x120 - 24"x48"

MA142 CENERE

9 mm

60x120 - 24"x48"

MA144 TORTORA

9 mm

60x120 - 24"x48"

MA146 PESCA

9 mm

60x120 - 24"x48"

MA147 OLIVA

9 mm

60x120 - 24"x48"

MA145 INCENSO

# MATERIA

ELEGANT . CONCRETE

## HARI

### GESSO

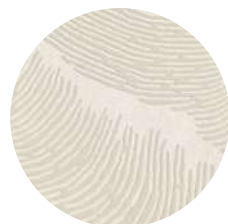

6 mm

120x280 - 48"x112"

MA148 GESSO

### CEMENTO

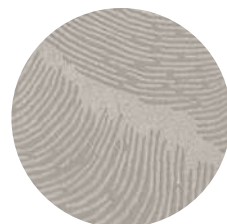

6 mm

120x280 - 48"x112"

MA150 CEMENTO

### SANDALO

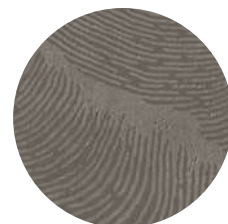

6 mm

120x280 - 48"x112"

MA152 SANDALO

### SETA



6 mm

120x280 - 48"x112"

MA149 SETA

### CENERE



6 mm

120x280 - 48"x112"

MA151 CENERE

### TORTORA

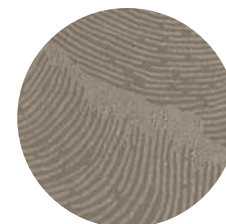

6 mm

120x280 - 48"x112"

MA153 TORTORA

### PESCA



6 mm

120x280 - 48"x112"

MA155 PESCA

### OLIVA

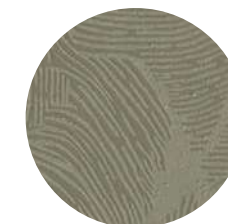

6 mm

120x280 - 48"x112"

MA156 OLIVA

### INCENSO



6 mm

120x280 - 48"x112"

MA154 INCENSO

9 mm

60x120 - 24"x48"

MA157 GESSO

9 mm

60x120 - 24"x48"

MA159 CEMENTO

9 mm

60x120 - 24"x48"

MA161 SANDALO

9 mm

60x120 - 24"x48"

MA158 SETA

9 mm

60x120 - 24"x48"

MA160 CENERE

9 mm

60x120 - 24"x48"

MA162 TORTORA

9 mm

60x120 - 24"x48"

MA164 PESCA

9 mm

60x120 - 24"x48"

MA165 OLIVA

9 mm

60x120 - 24"x48"

MA163 INCENSO

## LINOVA

### GESSO

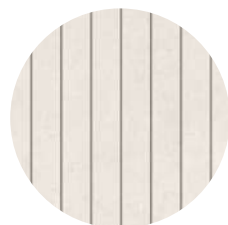

6 mm

120x280 - 48"x112"

MA166 GESSO

### CEMENTO

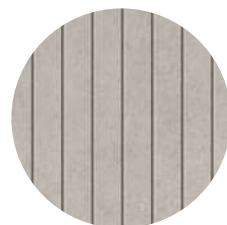

6 mm

120x280 - 48"x112"

MA168 CEMENTO

### SANDALO



6 mm

120x280 - 48"x112"

MA170 SANDALO

### SETA



6 mm

120x280 - 48"x112"

MA167 SETA

### CENERE

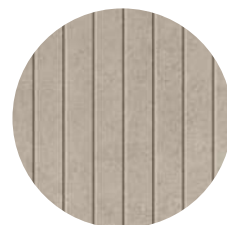

6 mm

120x280 - 48"x112"

MA169 CENERE

### TORTORA

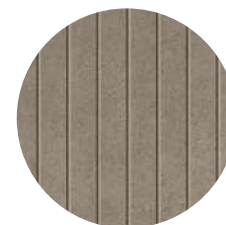

6 mm

120x280 - 48"x112"

MA171 TORTORA

### PESCA



6 mm

120x280 - 48"x112"

MA173 PESCA

### OLIVA



6 mm

120x280 - 48"x112"

MA174 OLIVA

### INCENSO

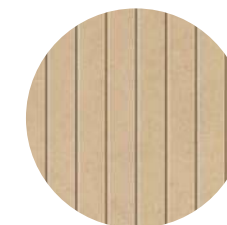

6 mm

120x280 - 48"x112"

MA172 INCENSO

9 mm

60x120 - 24"x48"

MA094 GESSO

9 mm

60x120 - 24"x48"

MA096 CEMENTO

9 mm

60x120 - 24"x48"

MA098 SANDALO

9 mm

60x120 - 24"x48"

MA095 SETA

9 mm

60x120 - 24"x48"

MA097 CENERE

9 mm

60x120 - 24"x48"

MA099 TORTORA

9 mm

60x120 - 24"x48"

MA101 PESCA

9 mm

60x120 - 24"x48"

MA102 OLIVA

9 mm

60x120 - 24"x48"

MA100 INCENSO

# MATERIA

ELEGANT . CONCRETE

## MOSAICO MINI BAGUETTE 3D

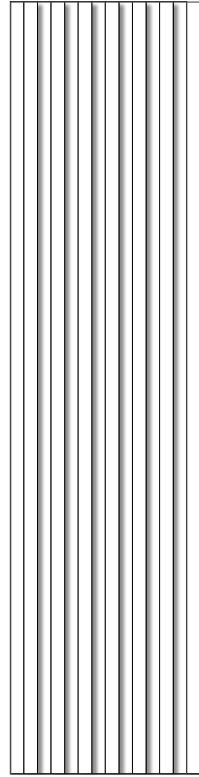

**9 mm**

**30x120** - 12"x48"

MA103 GESSO  
MA104 SETA  
MA105 CEMENTO  
MA106 CENERE  
MA107 SANDALO  
MA108 TORTORA  
MA109 INCENSO  
MA110 PESCA  
MA111 OLIVA

## BATTISCOPIA

**9 mm**

**4,6x60** - 1<sup>3</sup>/<sub>4</sub>"x24"

MA175 GESSO  
MA176 SETA  
MA177 CEMENTO  
MA178 CENERE  
MA179 SANDALO  
MA180 TORTORA

## MOSAICO LISTELLATO

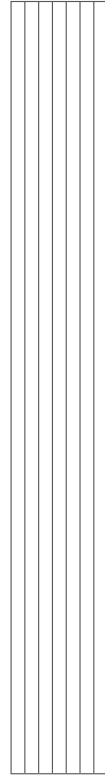

**9 mm**

**15x120** - 6"x48"

MA112 GESSO  
MA113 SETA  
MA114 CEMENTO  
MA115 CENERE  
MA116 SANDALO  
MA117 TORTORA  
MA118 INCENSO  
MA119 PESCA  
MA120 OLIVA

## BATTISCOPIA

**9 mm**

**4,6x120** - 1<sup>3</sup>/<sub>4</sub>"x48"

MA184 GESSO  
MA185 SETA  
MA186 CEMENTO  
MA187 CENERE  
MA188 SANDALO  
MA189 TORTORA

## MOSAICO 3x3 ECO MATERIA

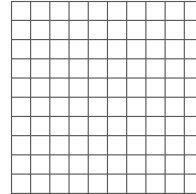

**3 mm**

**30x30** - 12"x12"

MA202 GESSO  
MA204 CEMENTO  
MA206 SANDALO  
MA203 SETA  
MA205 CENERE  
MA207 TORTORA  
MA209 PESCA  
MA208 INCENSO  
MA210 OLIVA

## MOSAICO 1x1 ECO MATERIA

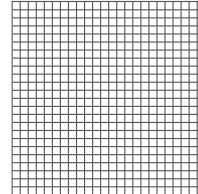

**4 mm**

**30x30** - 12"x12"

MA121 GESSO  
MA123 CEMENTO 24  
MA125 SANDALO 24  
MA122 SETA  
MA124 CENERE 24  
MA126 TORTORA  
MA128 PESCA  
MA127 INCENSO  
MA129 OLIVA

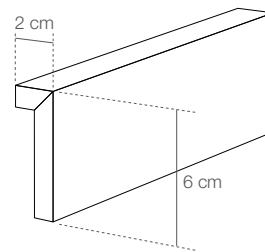

## CLOSE

**9 mm**

**6x60** - 2<sup>3</sup>/<sub>8</sub>"x24"

MA211 GESSO  
MA212 SETA  
MA213 CEMENTO  
MA214 CENERE  
MA215 SANDALO  
MA216 TORTORA  
MA217 INCENSO  
MA218 PESCA  
MA219 OLIVA

## IMBALLI\_PACKAGING\_EMBALLAGES\_VERPACKUNGEN

MATERIA	Thickness	Pezzi per scatola	M <sup>2</sup> per scatola	Kg per scatola	Scatole per pallet
120x280 - 48"x112"	6	1	3,36	47,4	20
120x120 - 48"x48"	6	2	2,88	41	24
60x120 - 24"x48"	6	3	2,16	32	30
120x120 - 48"x48"	9	2	2,88	67	20
120x120 - 48"x48" GRIP	9	2	2,88	67	20
60x120 - 24"x48"	9	2	1,44	27,9	30
60x120 - 24"x48" GRIP	9	2	1,44	27,9	30
80x80 - 32"x32"	9	2	1,28	24,8	40
80x80 - 32"x32" GRIP	9	2	1,28	24,8	40
60x60 - 24"x24"	9	3	1,08	21	40
SKE 2.0 120x120 - 48"x48"	20	1	1,44	67	18
SKE 2.0 60x120 - 24"x48"	20	1	0,72	33,4	30
Trama 60x120 - 24"x48"	9	2	1,44	27,9	30
Edelis 120x280 - 48"x112"	6	1	3,36	47,4	20
Edelis 60x120 - 24"x48"	9	2	1,44	27,9	30
Hari 120x280 - 48"x112"	6	1	3,36	47,4	20
Hari 60x120 - 24"x48"	9	2	1,44	27,9	30
Linova 120x280 - 48"x112"	6	1	3,36	47,4	20
Linova 60x120 - 24"x48"	9	2	1,44	27,9	30
Mosaico Mini Baguette 3D 30x120 - 12"x48"	9	2	0,72	14	10
Mosaico listellato 15x120 - 6"x48"	9	6	1,08	21	30
Mosaico Eco Materia 30x30 - 12"x12" Tessere 3x3	3	10	0,9	4,5	72
Mosaico Eco Materia 30x30 - 12"x12" Tessere 1x1	4	8	0,72	5	72
Battiscopa 4,6x60 - 1 <sup>3</sup> / <sub>4</sub> "x24"	9	14		9,00	56
Battiscopa 4,6x120 - 1 <sup>3</sup> / <sub>4</sub> "x48"	9	6		8,00	60
Close 6x60 - 2 <sup>3</sup> / <sub>8</sub> "x24"	9	1	-	-	-

## VARIAZIONE CROMATICA\_SHADE VARIATION\_VARIATION CHROMATIQUE\_CHROMATISCHE ABWEICHUNG



**V1**  
aspetto uniforme  
uniform appearance  
aspect uniforme  
Gleichmäßiges Bild



**V2**  
lieve variazione  
slight variation  
légère différence de nuance  
Leichte Abweichung



**V3**  
moderata variazione  
moderate variation  
variation modérée  
Mäßige Abweichung



**V4**  
forte variazione  
substantial variation  
variation intense  
Stärke Abweichung

CARATTERISTICHE E PROPRIETÀ - CHARACTERISTICS OR PROPERTIES CARACTERISTIQUES OU PROPRIETES - EIGENSCHAFTEN UND GÜTEMERKMALE	NORME - STANDARDS NORMES - NORMEN	SECONDO LE NORME - COMPLIANCE WITH STANDARDS - CONFORME AUX NORMES - ENTSPRECHEND DEN NORMEN UNI EN 14411 G - GRUPPO BIA UGL				
			6 mm 120x280	6 mm	9 mm	9 mm <b>GRIP</b> SKE 2.0
<b>RESISTENZA ALLE MACCHIE</b> - RESISTANCE TO STAIN - RESISTANCE AUX TACHES FLECKENFESTIGKEIT	ISO 10545-14	VALORE DICHIARATO - DECLARED VALUE - VALEUR DECLAREE - ANGEGEBENER WERT	CLASSE 5	CLASSE 5	CLASSE 5	CLASSE 5
<b>RESISTENZA AGLI AGENTI CHIMICI</b> - CHEMICAL RESISTANCE - RESISTANCE A L'ATTAQUE CHIMIQUE - BASTÄNDIGKEIT GEGEN CHEMIKALIEN	ISO 10545-13	UB MIN.	UA ULA	UA ULA	UA ULA UHA	UA ULA UHA
<b>RESISTENZA ALLO SCIVOLAMENTO</b> - SLIP RESISTANCE - RÉSISTANCE AU GLISSEMENT - BESTIMMUNG DER RUSTSCHEMMENDE EIGENSCHAFT <b>COEFFICIENTE D'ATTRITO</b> - DYNAMIC COEFFICIENT OF FRICTION - COEFFICIENT DE FRICTION DYNAMIQUE - DYNAMISCHER REIBUNGSKOEFFIZIENT	DIN EN 16165: 2021 ANNEX B	-	R9	R10	R10	R11
	DIN EN 16165: 2021 ANNEX A	-	A	B	B	C
	BS-7976 PTV	≥ 36	-	COMPLIANT	COMPLIANT	COMPLIANT
	DCOF BOT 3000	WET ≥ 0,42	COMPLIANT	COMPLIANT	COMPLIANT	COMPLIANT
<b>RESISTENZA ALLA FLESSIONE</b> - BENDING STRENGTH - RESISTANCE À LA FLEXION - BIEGEZUGFESTIGKEIT	ISO 10545-4	≥ 35 N/mm²	52	52	54	9 mm 54 20 mm 49
<b>SFORZO DI ROTTURA</b> - BREAKING STRENGTH IN N - FORCE DE RUPTURE EN N - BRUCHLAST IN N	ISO 10545-4	≥ 700 N (sp < 7,5mm) ≥ 1300 N (sp ≥ 7,5mm)	1350	1350	2157	9 mm 2157 20 mm 11789
<b>ASSORBIMENTO D'ACQUA</b> - WATER ABSORPTION - ABSORPTION D'EAU - WASSERAUFNAHME	ISO 10545-3	≤ 0,5 %	AVERAGE VALUE 0,08%			
<b>RESISTENZA ALL'ABRASIONE PROFONDA</b> - RESISTANCE TO DEEP ABRASION RESISTANCE A L'ABRASION PROFONDE - WINDERSTÄNDSFAKKEIT GEGEN TIEFENABRIEB	ISO 10545-6	≤ 175 mm³	139	139	102	102 123
<b>RESISTENZA AGLI SBALZI TERMICI</b> - THERMAL SHOCK RESISTANCE - RESISTANCE AUX ECARTS THERMIQUES - TEMPERATURWECHSELBESTÄNDIGKEIT	ISO 10545-9	TEST SUPERATO SECONDO EN ISO 10545-1 - PASS ACCORDING EN ISO 10545-1 - TEST OBTENUS SELON EN ISO 10545-1 - TEST LAUT EN ISO 10545-1 BESTANDEN	NESSUN DANNO - NO DAMAGE - AUCUN DOMMAGE - KEIN SCHADEN			
<b>QUALITÀ DELLA SUPERFICIE</b> - SURFACE QUALITY - QUALITE DE LA SURFACE - OBERFLÄCHENQUALITÄT		IL 95% MIN DELLE PISTRELLE DEVE ESSERE ESENTE DA DIFETTI VISIBILI - AT LEAST 95% OF THE TILE MUST BE FREE FROM VISIBLE FLAWS - 95% MIN DES CARREUX NE DOIVENT PRÉSENTER AUCUN DÉFAUT VISIBLE - MINDESTENS 95% DER FLIESEN MÜSSEN FREI VON SICHTBAREN	CONFORME ALLE NORME - COMPLIES WITH STANDARD - CONFORME AUX NORMES - NORMGERECHT			
<b>DEVIATIONE MASSIMA DI RETTILINEITÀ IN %</b> - MAXIMUM STRAIGHTNESS DEVIATION IN % - MARGE DE TOLERANCE DE RECTITUDE EN % - ZULAESSIGE HOECHSTABWEICHUNG DER KANTENGERADHEIT IN PROZENTEN		± 0,5 % ± 1,5 mm	CONFORME ALLE NORME - COMPLIES WITH STANDARD - CONFORME AUX NORMES - NORMGERECHT			
<b>DEVIATIONE AMMISSIBILE IN %, DELLO SPESSORE MEDIO DI OGNI PIASTRELLA DALLA DIMENSIONE DI FABBRICAZIONE</b> - ADMITTED DEVIATION, IN %, OF THE AVERAGE THICKNESS OF EACH TILE FROM THE PRODUCTION DIMENSIONS - MARGE DE TOLÉRANCE, EN POURCENTAGE, ENTRE L'ÉPAISSEUR MOYENNE DE CHAQUE CARREAU ET LA DIMENSION DE FABRICATION - ZULÄSSIGE ABWEICHUNG DER DURCHSCHNITTSDICKE JEDER FLIESE VOM HERSTELLMASS IN PROZENTEN	ISO 10545-2	± 0,5 % ± 0,5 mm	CONFORME ALLE NORME - COMPLIES WITH STANDARD - CONFORME AUX NORMES - NORMGERECHT			
<b>DEVIATIONE MASSIMA DI ORTOGONALITÀ IN %</b> - MAXIMUM RIGHT-ANGLE DEVIATION IN % - MARGE DE TOLERANCE D'ANGULARITE IN % - HOECHSTABWEICHUNG DER RECHTWINKLIGKEIT IN PROZENTEN		± 0,5 % ± 2,0 mm	CONFORME ALLE NORME - COMPLIES WITH STANDARD - CONFORME AUX NORMES - NORMGERECHT			
<b>PLANARITÀ</b> - FLATNESS - PLANEITE - EBENFLÄCHIGKEIT		± 0,5 % ± 2,0 mm	CONFORME ALLE NORME - COMPLIES WITH STANDARD - CONFORME AUX NORMES - NORMGERECHT			
<b>LUNGHEZZA E LARGHEZZA</b> - LENGTH AND WIDTH - LONGUEUR ET LARGEUR - LÄNGE UND BREITE		± 0,6 % ± 2,0 mm	CONFORME ALLE NORME - COMPLIES WITH STANDARD - CONFORME AUX NORMES - NORMGERECHT			
<b>RESISTENZA AL GELO</b> - FROST RESISTANCE - RESISTANCE AU GEL - FROSTBESTÄNDIGKEIT	ISO 10545-12	TEST SUPERATO SECONDO EN ISO 10545-1 - PASS ACCORDING EN ISO 10545-1 - TEST OBTENUS SELON EN ISO 10545-1 - TEST LAUT EN ISO 10545-1 BESTANDEN	NESSUN DANNO - NO DAMAGE - AUCUN DOMMAGE - KEIN SCHADEN			
<b>RILASCIO DI SOSTANZE PERICOLOSE</b> - RELEASE OF HAZARDOUS SUBSTANCES REJET DE SUBSTANCES DANGEREUSES - FREISETZUNG GEFÄHRLICHER STOFFE	DM-1-2-2007-Reg-CE 193-2004	VALORE DICHIARATO - DECLARED VALUE - VALEUR DECLAREE - ANGEGEBENER WERT	CONFORME ALLE NORME, NO VARIAZIONI - COMPLIES WITH STANDARD, NO VARIATION - CONFORME AUX NORMES, PAS DE CHANGEMENTS - NORMGERECHT, KEINE ÄNDERUNG			
<b>SKE2.0</b>						
<b>CARICO STATICO</b> - STATIC LOAD - CHARGE STATIQUE - STATISCHER BELASTUNG	EN 12825	VALORE DICHIARATO - DECLARED VALUE - VALEUR DECLAREE - ANGEGEBENER WERT	CENTRO 9,6 KN - CENTRE 9,6 KN CENTRO LATO 6,5 KN - CENTRE POINT OF SIDES 6,5 KN DIAGONALE 8,19 KN - DIAGONAL 8,19 KN (CLASSE 3)			
<b>CARICO DINAMICO, PROVA DI URTO DI CORPI DURI</b> - DYMANIC LAOD CAPACITY, HAND OBJECT IMPACT TEST - C. STATIQUE, ESSAI DE CHOC DE CORPS DURS - STATISCHER BELASTUNG, AUSWIRKUNGEN TEST DER HARTEN KÖRPER	EN 12825	VALORE DICHIARATO - DECLARED VALUE - VALEUR DECLAREE - ANGEGEBENER WERT	TEST NON SUPERATO - TEST NOT PASSED TEST A ECHOUÉ - TEST FEHLGESCHLAGEN			
<b>CARICO DINAMICO, PROVA DI URTO DI CORPI MORBIDI</b> - DYMANIC LAOD CAPACITY, SOFT OBJECT IMPACT TEST C. STATIQUE, ESSAIS D'IMPACT DE CORPS MOUS - TATISCHER BELASTUNG, AUSWIRKUNGEN PRÜFUNG VON WEICHEN KÖRPERN	EN 12825	VALORE DICHIARATO - DECLARED VALUE - VALEUR DECLAREE - ANGEGEBENER WERT	TEST SUPERATO - TEST PASSED TEST REUSSI - TEST BESTANDEN			
<b>RESISTENZA ALLA FLESSIONE, CARICO DI ROTTURA IN N</b> - BENDIND STRENGTH, BREAKING FORCE IN N - RESISTANCE À LA LFEXION, CHARGE DE ROPTURE IN N - BIEGEFESTIGKEIT, BRUCHLAST EN N	EN 1339	-	CLASSE U 14 KN 14,38			
<b>CARICO DI ROTTURA IN MPA</b> - BREAKING FORCE IN MPA - CHARGE DE ROPTURE IN MPA - BRUCHLAST EN MPA		-	MPA 46,5			



**Kronos 2 ceramiche S.p.A.**

Sede legale: Strada delle Fornaci, 20 41126 Modena Italy  
Sede amministrativa: Via Giardini, 62 41042 Fiorano Modenese (Mo) Italy  
tel. +39 0536 927711 - info@kronosceramiche.com  
www.kronosceramiche.com

